

# Hermetic Infrared Emitting Diode

OP123, OP124, OP223, OP224



## Features:

- Hermetically sealed package
- Mechanically and spectrally matched to other OPTEK devices
- Designed for direct mount to PCBoard

## Description:

Each **OP123** and **OP124** device is a 935 nanometer (nm) high intensity gallium arsenide infrared emitting diode (GaAs), mounted in a miniature hermetically sealed “pill” package with an enhanced temperature range and a high power output. These devices are designed for direct mounting to PCBoards.

Each **OP223** and **OP224** device is an 890 nm gallium aluminum arsenide infrared emitting diode (GaAlAs), mounted in a hermetically sealed “pill” package with an enhanced temperature range and a narrow irradiance pattern that provides high on-axis intensity for excellent coupling efficiency. These devices offer significantly higher power output than GaAs at equivalent drive currents and have a wavelength that is matched to silicon’s peak response. Their small package size permits high device density mounting.

All these LEDs are mechanically and spectrally matched to the OP300 series, OP600 series and OP640 series devices.

*Please refer to Application Bulletins 208 and 210 for additional design information and reliability (degradation) data, and to Application Bulletin 202 for pill-type soldering to PCBoard.*

## Applications:

- Non-contact reflective object sensor
- Assembly line automation
- Machine automation
- Machine safety
- End of travel sensor
- Door sensor

Ordering Information		
Part Number	LED Peak Wavelength	Total Beam Angle
<b>OP123</b>	935 nm	24°
<b>OP124</b>		
<b>OP223</b>	890 nm	
<b>OP224</b>		

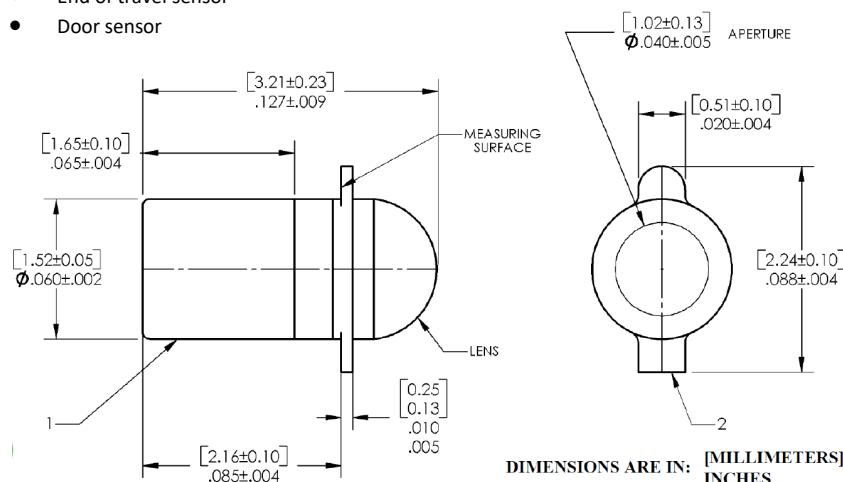

Pin #	LED	Sensor
1	Anode	Collector
2	Cathode	Emitter

# Hermetic Infrared Emitting Diode

## OP123, OP124, OP223, OP224



### Electrical Specifications

**Absolute Maximum Ratings** ( $T_A = 25^\circ\text{C}$  unless otherwise noted)

Storage Temperature Range	-65° C to +150° C
Operating Temperature Range	-65° C to +125° C
Reverse Voltage	2.0 V
Continuous Forward Current	100 mA
Peak Forward Current (2 $\mu\text{s}$ pulse with 0.1% duty cycle)	1.0 A
Lead Soldering Temperature [1/16 inch (1.6 mm) from case for 5 seconds with soldering iron]	260° C <sup>(1)(2)</sup>
Power Dissipation	100 mW <sup>(1)</sup>

**Electrical Characteristics** ( $T_A = 25^\circ\text{C}$  unless otherwise noted)

SYMBOL	PARAMETER	MIN	TYP	MAX	UNITS	TEST CONDITIONS
$E_{E(APT)}^{(3)}$	Apertured Radiant Incidence	0.40	-	-	mW/cm <sup>2</sup>	$I_F = 50\text{ mA}^{(4)}$
	OP123	1.00	-	-		
	OP124	1.00	-	-		
	OP223	3.50	-	-		
$V_F$	Forward Voltage	-	-	1.50	V	$I_F = 50\text{ mA}$
	OP123, OP124 OP223, OP224	-	-	1.80		
$I_R$	Reverse Current	-	-	100	$\mu\text{A}$	$V_R = 2.0\text{ V}$
$\lambda_P$	Wavelength at Peak Emission	-	935	-	nm	$I_F = 50\text{ mA}$ $I_F = 50\text{ mA}$
	OP123, OP124 OP223, OP224	-	890	-		
$\beta$	Spectral Bandwidth between Half Power Points	-	50	-	nm	$I_F = 50\text{ mA}$ $I_F = 10\text{ mA}$
	OP123, OP124 OP223, OP224	-	80	-		
$\Delta\lambda_P/\Delta T$	Spectral Shift with Temperature	-	+0.30	-	nm/° C	$I_F = \text{Constant}$
	OP123, OP124 OP223, OP224	-	+0.18	-		
$\Theta_{HP}$	Emission Angle at Half Power Points	-	24	-	Degree	$I_F = 50\text{ mA}$
$t_r$	Output Rise Time	-	1000	-	ns	$I_{F(PK)} = 100\text{ mA}$ , $PW = 10.0\ \mu\text{s}$ , D.C. = 10.0%
	OP123, OP124 OP223, OP224	-	500	-		
$t_f$	Output Fall Time	-	500	-	ns	
	OP123, OP124 OP223, OP224	-	250	-		

**Notes:**

- Refer to Application Bulletin 202 which reviews proper soldering techniques for pill-type devices.
- No clean or low solids. RMA flux is recommended. Duration can be extended to 10 seconds maximum when flow soldering.
- Derate linearly 1.50 mW/° C above 25° C.
- For OP123, OP124, OP223 and OP224,  $E_{E(APT)}$  is a measurement using a 0.031" (0.787 mm) diameter apertured sensor placed 0.50" (12.7 mm) from the measuring surface.  $E_{E(APT)}$  is not necessarily uniform within the measured area.

# Hermetic Infrared Emitting Diode

OP123, OP124, OP223, OP224



## Performance

OP123, OP124

Forward Voltage vs Forward Current vs Temperature

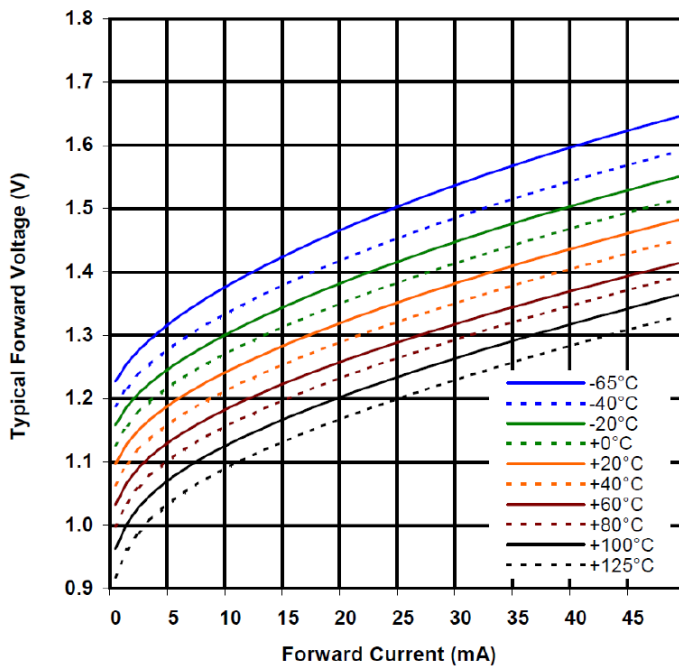

Optical Power vs  $I_F$  vs Temp

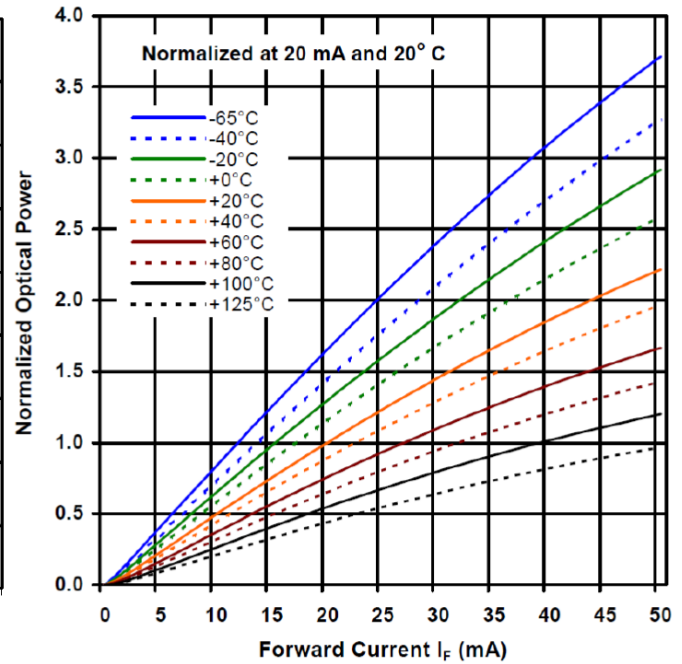

Distance vs Output Power vs Forward Current

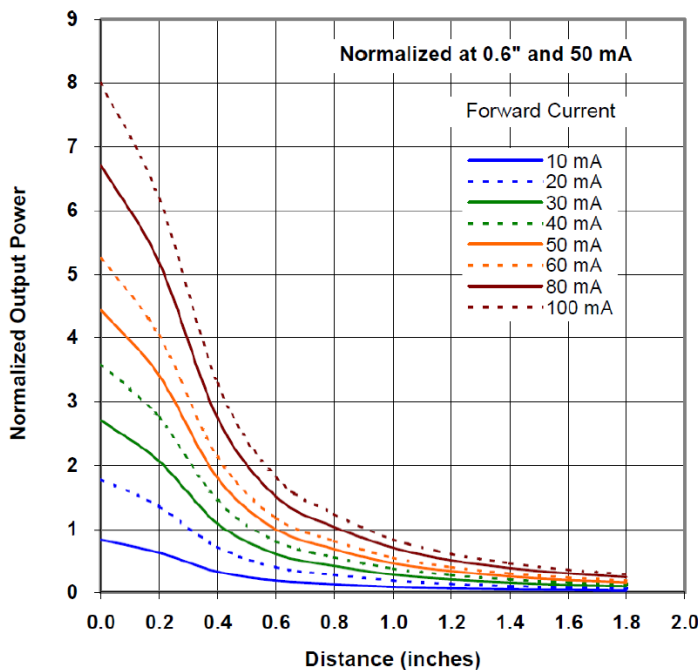

Normalized Intensity vs Beam Angle

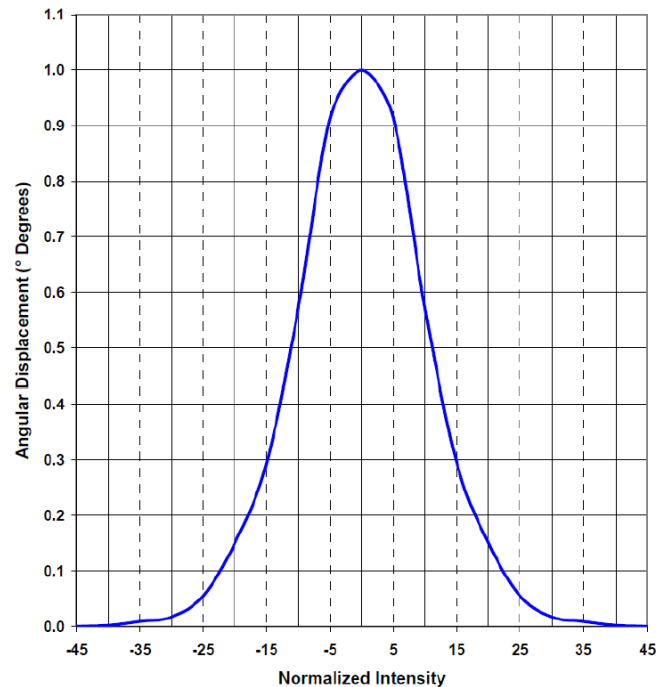

# Hermetic Infrared Emitting Diode

OP123, OP124, OP223, OP224



## Performance OP223, OP224

Forward Voltage vs Forward Current vs Temperature

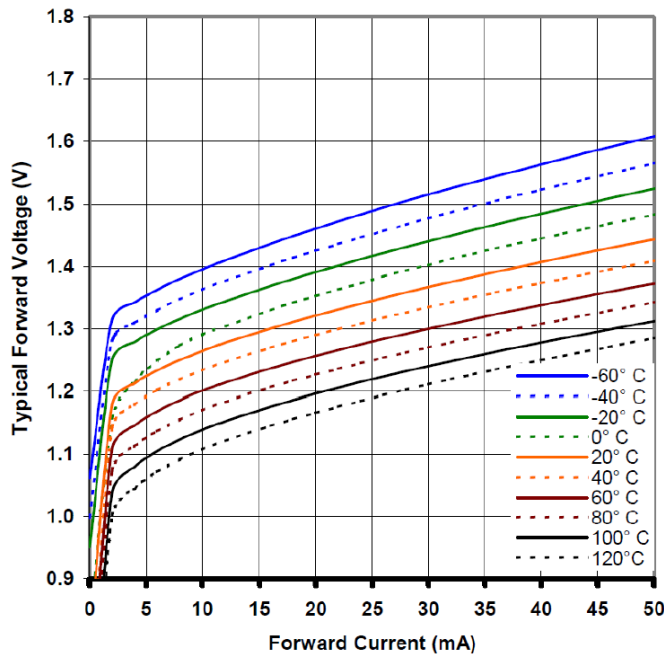

Optical Power vs  $I_F$  vs Temperature

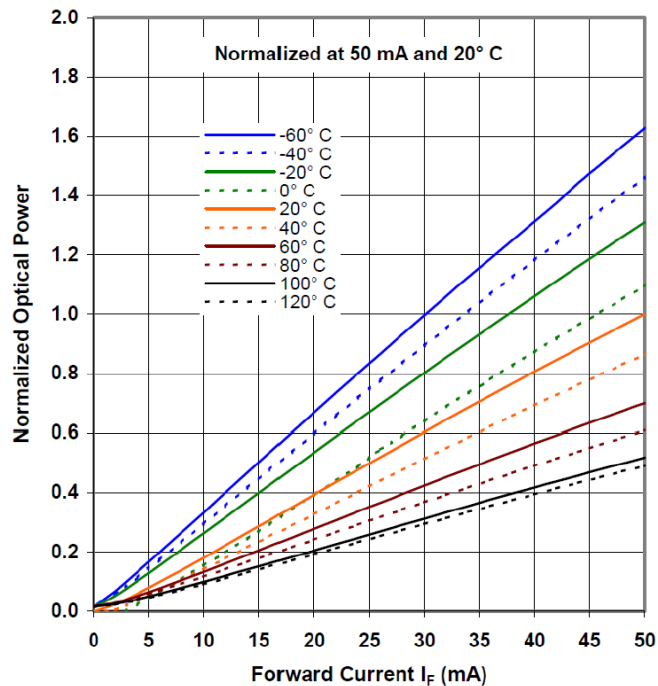

Distance vs Output Power vs Forward Current

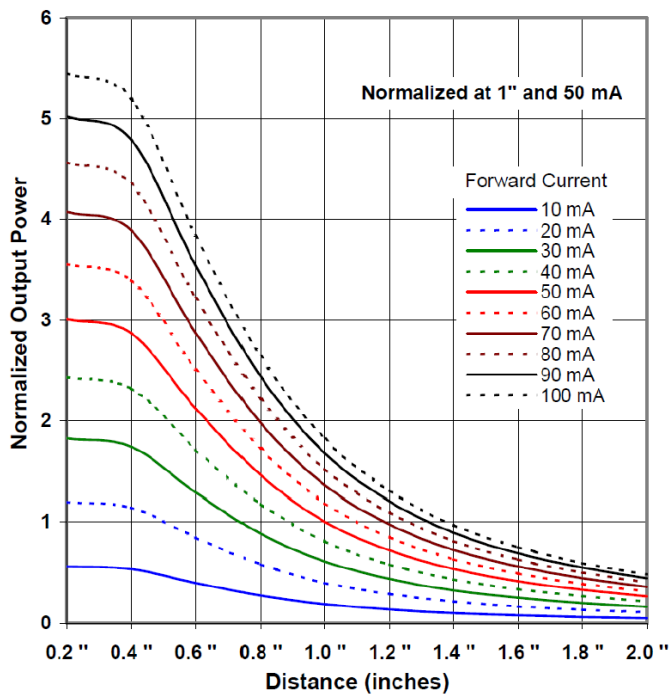

Normalized Intensity vs Beam Angle

